



SC70, Low-Power, General-Purpose, Dual-Supply, Rail-to-Rail Op Amps

General Description

The MAX4493/MAX4494/MAX4495 single/dual/quad general-purpose operational amplifiers are designed for use in systems powered with dual supplies from $\pm 2.25\text{V}$ to $\pm 5.5\text{V}$ or with a single supply of $+4.5\text{V}$ to $+11\text{V}$. These op amps provide a unity-gain bandwidth of 5MHz with only $770\mu\text{A}$ of quiescent current per amplifier. The wide input common-mode range extends from 200mV beyond the negative rail to within 1.5V of the positive supply rail while the output swings within 10mV ($R_L = 100\text{k}\Omega$) of either rail.

These amplifiers have excellent (110dB) open-loop gain with very low THD+N of 0.002% ($f = 1\text{kHz}$). The single MAX4493 is available in a tiny 5-pin SC70 package and the dual MAX4494 is available in the space-saving 8-pin SOT23. The quad MAX4495 is available in both 14-pin TSSOP and 14-pin SO packages. All products are rated at the automotive temperature range of -40°C to $+125^\circ\text{C}$.

Applications

Battery-Powered Systems
DAC Output Amplifiers
Industrial Control Systems
Voltage Reference Generators
Signal Conditioning

Typical Operating Characteristic

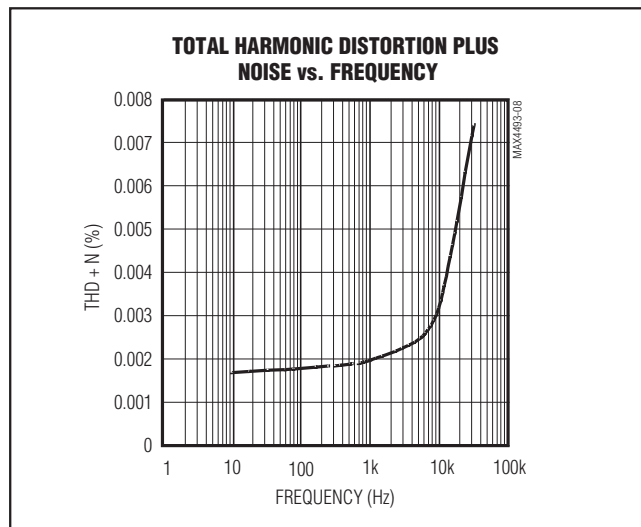

Typical Operating Circuit appears at end of data sheet.



For pricing, delivery, and ordering information, please contact Maxim Direct at 1-888-629-4642, or visit Maxim's website at www.maxim-ic.com.

Features

- ◆ $770\mu\text{A}$ Supply Current per Amplifier
- ◆ Operates from Dual $\pm 2.25\text{V}$ to $\pm 5.5\text{V}$ Supplies
- ◆ 5MHz Gain-Bandwidth Product
- ◆ Rail-to-Rail Output Swing
- ◆ Input Voltage Range Extends 200mV Below the Negative Rail
- ◆ 110dB Open-Loop Gain ($R_L = 100\text{k}\Omega$)
- ◆ Low THD+N of 0.002% ($f = 1\text{kHz}$)
- ◆ No Phase Reversal for Overdriven Inputs
- ◆ Unity-Gain Stable
- ◆ Available in Space-Saving Packages
 - 5-Pin SC70 (MAX4493)
 - 8-Pin SOT23 (MAX4494)
 - 14-Pin TSSOP (MAX4495)

Ordering Information

PART	TEMP RANGE	PIN-PACKAGE	TOP MARK
MAX4493AXK+T	-40°C to $+125^\circ\text{C}$	5 SC70	ABR
MAX4493AXK/V+T	-40°C to $+125^\circ\text{C}$	5 SC70	+AUE
MAX4493AUK+T	-40°C to $+125^\circ\text{C}$	5 SOT23	ADPG
MAX4494AKA+T	-40°C to $+125^\circ\text{C}$	8 SOT23	AAEM
MAX4494AKA/V+T	-40°C to $+125^\circ\text{C}$	8 SOT23	+AEQP
MAX4494AUA+	-40°C to $+125^\circ\text{C}$	8 μMAX	—
MAX4494ASA+	-40°C to $+125^\circ\text{C}$	8 SO	—
MAX4495AUD+	-40°C to $+125^\circ\text{C}$	14 TSSOP	—
MAX4495ASD+	-40°C to $+125^\circ\text{C}$	14 SO	—

+ Denotes a lead(Pb)-free/RoHS-compliant package.

V denotes an automotive qualified part.

T = Tape and reel.

Pin Configurations

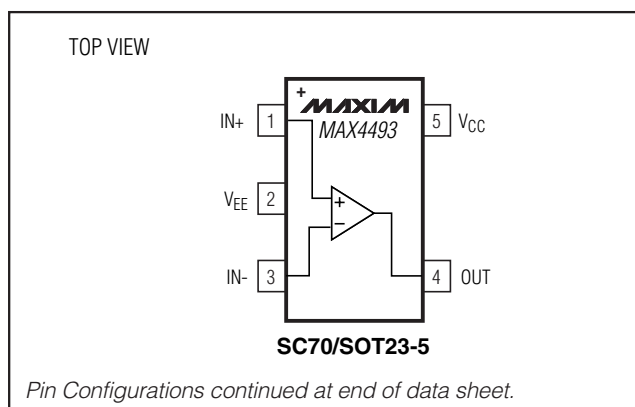

MAX4493/MAX4494/MAX4495

SC70, Low-Power, General-Purpose, Dual-Supply, Rail-to-Rail Op Amps

ABSOLUTE MAXIMUM RATINGS

Supply Voltage (V _{CC} to V _{EE}).....	+12V	8-Pin SOT23 (derate 9.1mW/°C above +70°C).....	727mW
Voltage from Any Pin to Ground or Any Other Pin	(V _{EE} - 0.3V) to (V _{CC} + 0.3V)	8-Pin μ MAX® (derate 4.5mW/°C above +70°C).....	362mW
Output Short-Circuit Duration to V _{CC} , V _{EE} , or Ground	Continuous	8-Pin SO (derate 5.9mW/°C above +70°C).....	471mW
Continuous Power Dissipation (T _A = +70°C)		14-Pin TSSOP (derate 9.1mW/°C above +70°C).....	727mW
5-Pin SC70 (derate 3.1mW/°C above +70°C).....	247mW	14-Pin SO (derate 8.3mW/°C above +70°C).....	667mW
5-Pin SOT23 (derate 7.1mW/°C above +70°C).....	571mW	Operating Temperature Range	-40°C to +125°C
		Storage Temperature Range	-65°C to +150°C
		Lead Temperature (soldering, 10s).....	+300°C

μ MAX is a registered trademark of Maxim Integrated products, Inc.

Stresses beyond those listed under "Absolute Maximum Ratings" may cause permanent damage to the device. These are stress ratings only, and functional operation of the device at these or any other conditions beyond those indicated in the operational sections of the specifications is not implied. Exposure to absolute maximum rating conditions for extended periods may affect device reliability.

DC ELECTRICAL CHARACTERISTICS

(V_{CC} = +5V, V_{EE} = -5V, R_L = 100k Ω to ground, T_A = -40°C to +125°C. Typical values are at T_A = +25°C, unless otherwise noted.)
(Note 1)

PARAMETER	SYMBOL	CONDITIONS	MIN	TYP	MAX	UNITS
Operating Supply Voltage Range	V _S	Guaranteed by PSRR test	± 2.25		± 5.5	V
Quiescent Supply Current per Amplifier	I _S			770	1100	μ A
Input Offset Voltage	V _{OS}	T _A = +25°C		0.3	5	mV
		T _A = T _{MIN} to T _{MAX}			10	
Input Offset Voltage Drift	TCV _{OS}			3		μ V/°C
Input Offset Voltage Channel Matching		MAX4494 and MAX4495		1		mV
Input Bias Current	I _B			0.2	1	μ A
Input Offset Current	I _{OS}			5	300	nA
Input Resistance	R _{IN}	Differential mode (-1V \leq V _{IN} \leq +1V)		250		k Ω
		Common mode (V _{EE} - 0.2V \leq V _{CM} \leq V _{CC} - 1.5V)		110		M Ω
Common-Mode Input Voltage Range	V _{CM}	Guaranteed by CMRR test	V _{EE} - 0.2V		V _{CC} - 1.5V	V
Common-Mode Rejection Ratio	CMRR	V _{EE} - 0.2V \leq V _{CM} \leq V _{CC} - 1.5V	65	90		dB
Power-Supply Rejection Ratio	PSRR	V _S = ± 2.25 V to ± 5.5 V	65	80		dB
Large-Signal Voltage Gain	A _{VOL}	R _L = 100k Ω , V _{EE} + 0.25V \leq V _{OUT} \leq V _{CC} - 0.25V	85	110		dB
		R _L = 1k Ω , V _{EE} + 0.5V \leq V _{OUT} \leq V _{CC} - 0.5V	65	90		
Output Voltage Swing	V _{OUT}	R _L = 100k Ω , V _{CC} - V _{OH} and V _{OL} - V _{EE}		10	150	mV
		R _L = 1k Ω , V _{CC} - V _{OH} and V _{OL} - V _{EE}		200	450	
Output Short-Circuit Current	I _{SC}	Sourcing or sinking		15		mA

Note 1: All devices are 100% production tested at T_A = +25°C. Limits over the operating temperature range are guaranteed by design and not production tested.

SC70, Low-Power, General-Purpose, Dual-Supply, Rail-to-Rail Op Amps

MAX4493/MAX4494/MAX4495

AC ELECTRICAL CHARACTERISTICS

($V_{CC} = +5V$, $V_{EE} = -5V$, $R_L = 100k\Omega$ to ground, $C_L = 15pF$, $T_A = +25^\circ C$, unless otherwise noted.)

PARAMETER	SYMBOL	CONDITIONS	MIN	TYP	MAX	UNITS
Gain-Bandwidth Product	GBWP			5		MHz
Full-Power Bandwidth	FPBW	$V_{OUT} = 5Vp-p$		190		kHz
Slew Rate	SR	$V_{OUT} = 5Vp-p$		3		V/ μs
Phase Margin				75		degrees
Gain Margin				15		dB
Total Harmonic Distortion Plus Noise	THD+N	$f = 1kHz$, $V_{OUT} = 5Vp-p$, $A_V = +1V/V$		0.002		%
Settling Time to 0.01%	t_s	$A_V = +1V/V$, $V_{OUT} = 5V$ step		4		μs
Input Capacitance	C_{IN}			2		pF
Input Noise Voltage Density	e_{IN}	$f = 1kHz$		8		nV/ \sqrt{Hz}
Input Noise Current Density	i_{IN}	$f = 1kHz$		0.2		pA/ \sqrt{Hz}
All-Hostile Crosstalk		$f = 1kHz$, MAX4494 and MAX4495		-100		dB
Capacitive-Load Stability		$A_V = +1V/V$, no sustained oscillations		300		pF
Power-Up Time	t_{ON}	$V_{OUT} = 1V$, 1 μs power supply rise-time		3		μs

Typical Operating Characteristics

($V_{CC} = +5V$, $V_{EE} = -5V$, $V_{CM} = 0V$, $R_L = 100k\Omega$ to ground, $C_L = 15pF$, $T_A = +25^\circ C$, unless otherwise noted.)

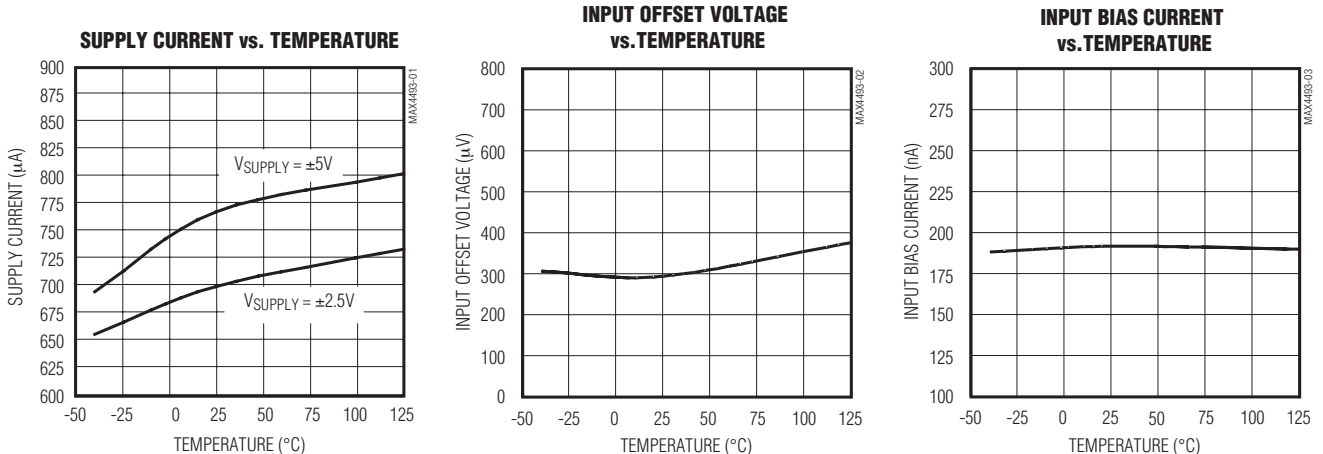

SC70, Low-Power, General-Purpose, Dual-Supply, Rail-to-Rail Op Amps

Typical Operating Characteristics (continued)

($V_{CC} = +5V$, $V_{EE} = -5V$, $V_{CM} = 0V$, $R_L = 100k\Omega$ to ground, $C_L = 15pF$, $T_A = +25^\circ C$, unless otherwise noted.)

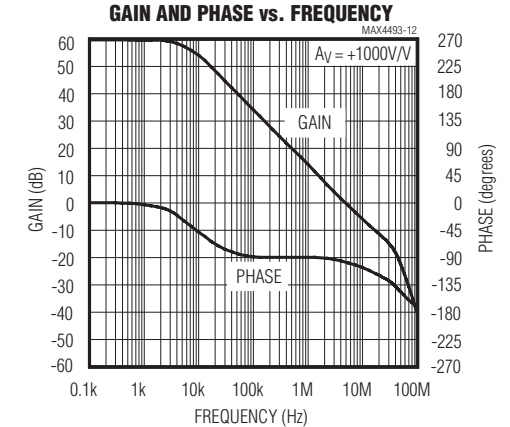
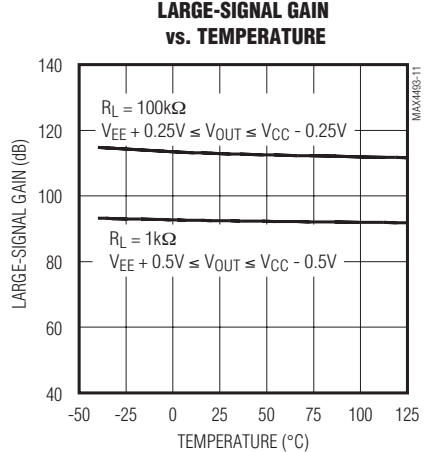
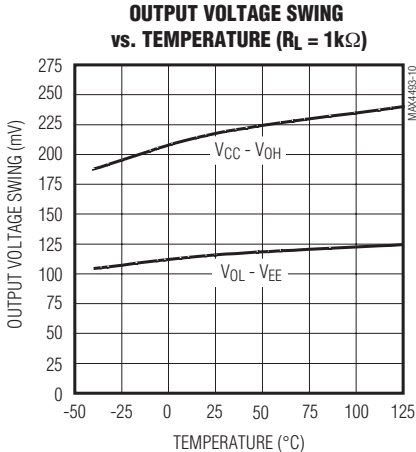
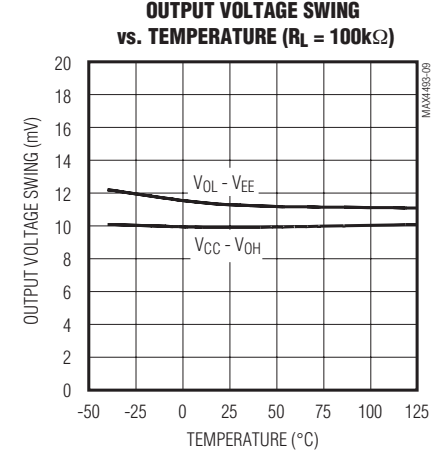
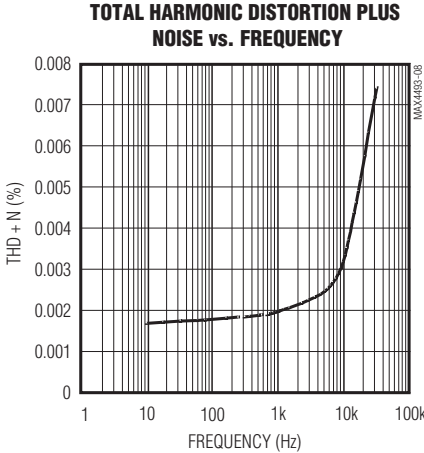
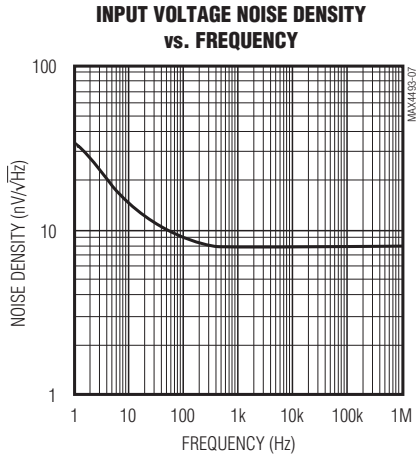
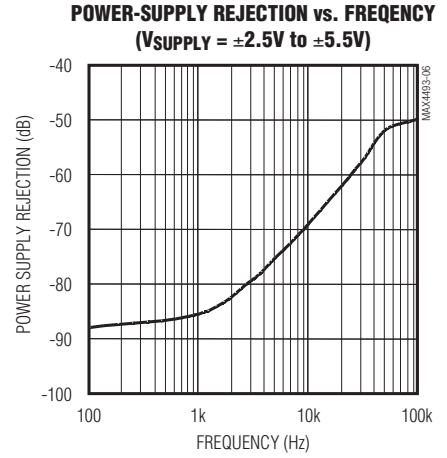
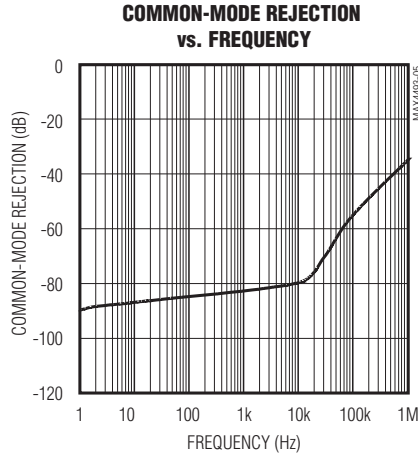
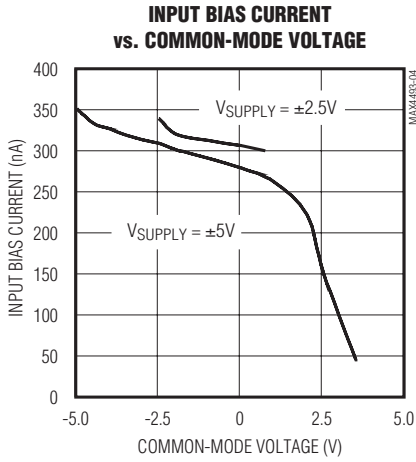

SC70, Low-Power, General-Purpose, Dual-Supply, Rail-to-Rail Op Amps

Typical Operating Characteristics (continued)

($V_{CC} = +5V$, $V_{EE} = -5V$, $V_{CM} = 0V$, $R_L = 100k\Omega$ to ground, $C_L = 15pF$, $T_A = +25^\circ C$, unless otherwise noted.)

MAX4493/MAX4494/MAX4495

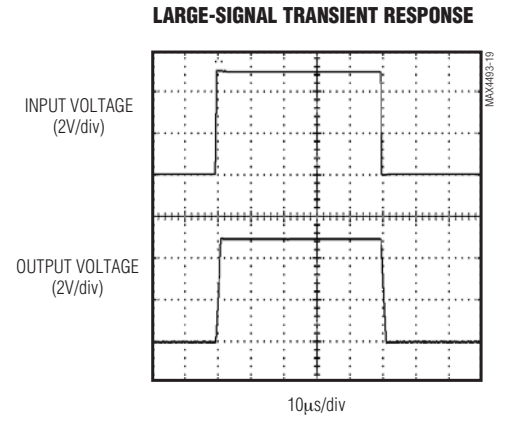
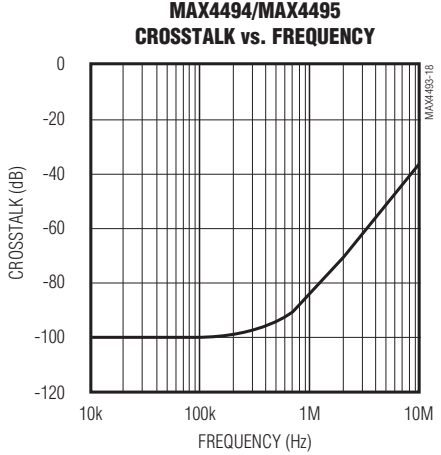
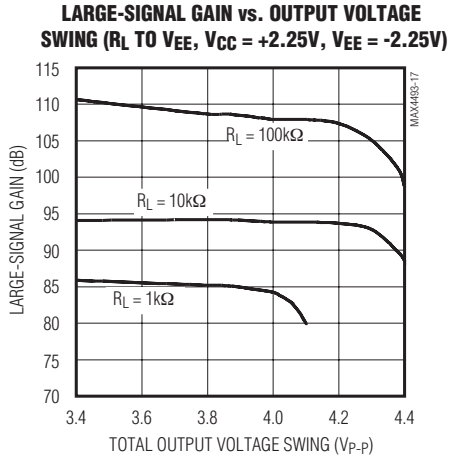
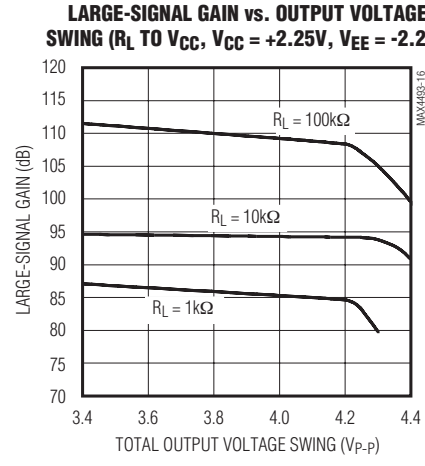
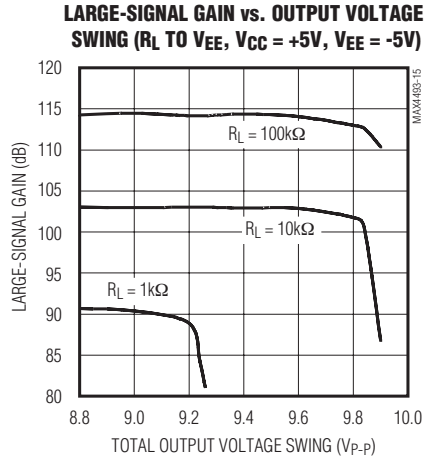
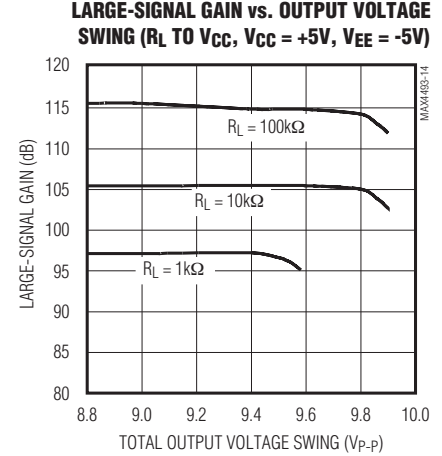
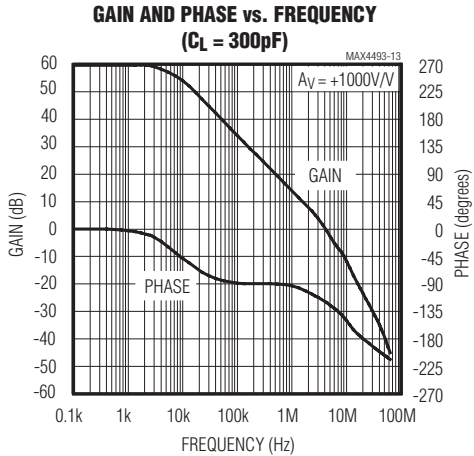

SC70, Low-Power, General-Purpose, Dual-Supply, Rail-to-Rail Op Amps

Typical Operating Characteristics (continued)

($V_{CC} = +5V$, $V_{EE} = -5V$, $V_{CM} = 0V$, $R_L = 100k\Omega$ to ground, $C_L = 15pF$, $T_A = +25^\circ C$, unless otherwise noted.)

SMALL-SIGNAL TRANSIENT RESPONSE

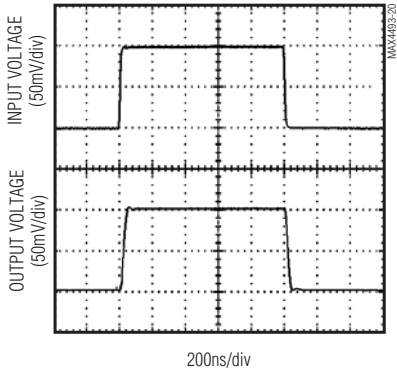

LARGE-SIGNAL CAPACITIVE-LOAD STABILITY ($C_L = 1200pF$)

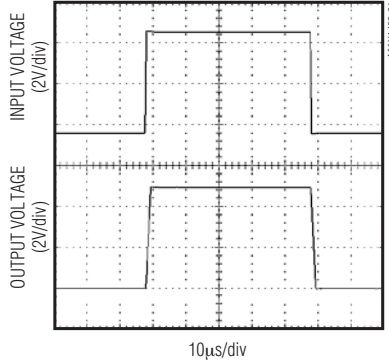

SMALL-SIGNAL CAPACITIVE-LOAD STABILITY ($C_L = 300pF$)

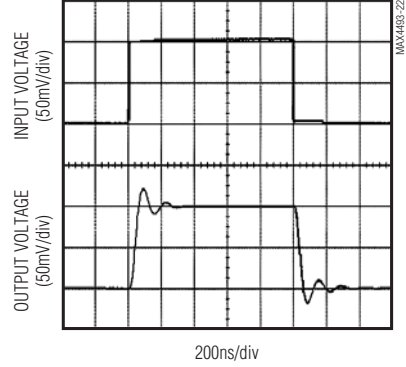

SMALL-SIGNAL TRANSIENT RESPONSE ($R_{ISO} = 15\Omega$, $C_L = 1000pF$)

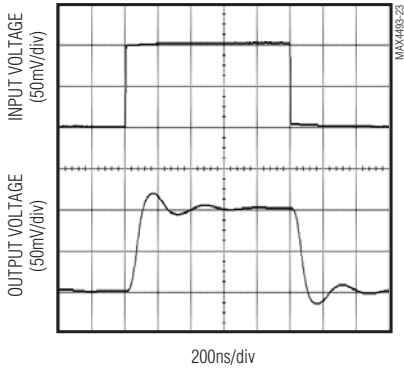

LARGE-SIGNAL TRANSIENT RESPONSE ($R_{ISO} = 15\Omega$, $C_L = 0.01\mu F$)

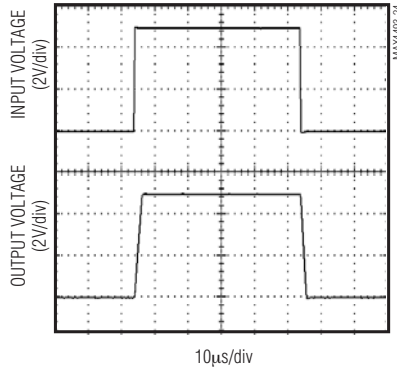

POWER-UP TIME ($V_{IN} = +1V$)

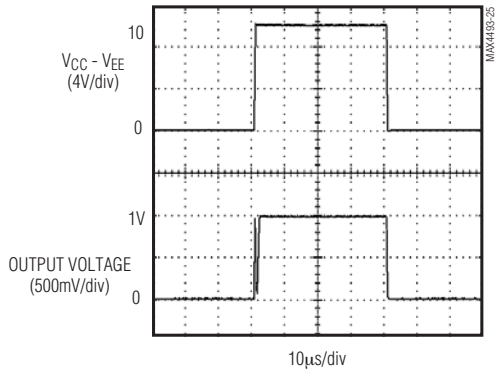

STABILITY vs. CAPACITIVE AND RESISTIVE LOADS

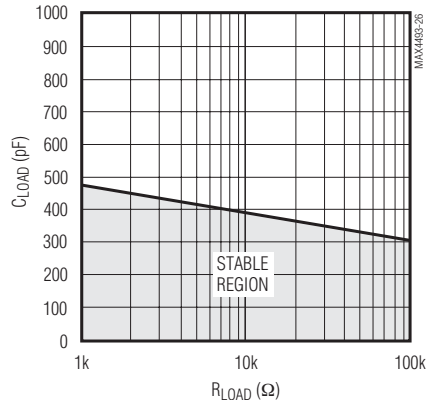

SC70, Low-Power, General-Purpose, Dual-Supply, Rail-to-Rail Op Amps

Pin Description

MAX4493/MAX4494/MAX4495

PIN			NAME	FUNCTION
MAX4493	MAX4494	MAX4495		
—	1	1	OUTA	Channel A Output
—	2	2	INA-	Channel A Inverting Input
—	3	3	INA+	Channel A Noninverting Input
—	7	7	OUTB	Channel B Output
—	6	6	INB-	Channel B Inverting Input
—	5	5	INB+	Channel B Noninverting Input
—	—	8	OUTC	Channel C Output
—	—	9	INC-	Channel C Inverting Input
—	—	10	INC+	Channel C Noninverting Input
—	—	14	OUTD	Channel D Output
—	—	13	IND-	Channel D Inverting Input
—	—	12	IND+	Channel D Noninverting Input
4	—	—	OUT	Output
1	—	—	IN+	Noninverting Input
3	—	—	IN-	Inverting Input
5	8	4	VCC	Positive Supply
2	4	11	VEE	Negative Supply

Applications Information

Rail-to-Rail Output Stage

The MAX4493/MAX4494/MAX4495 output stage can drive up to 1kΩ and still swing within 200mV of the rails.

Capacitive-Load Stability

Driving large capacitive loads can cause instability in many op amps. The MAX4493/MAX4494/MAX4495 are

stable with capacitive loads up to 300pF. The Capacitive-Load Stability graph in the *Typical Operating Characteristics* gives the stable operation region for capacitive versus resistive load. Stability with higher capacitive loads can be improved by adding an isolation resistor in series with the op-amp output, as shown in Figure 1. This resistor improves the circuit's phase margin by isolating the load capacitor from the amplifier's output. As seen in the *Typical Operating Characteristics*, driving capacitive loads with an isolation resistor exhibits some overshoot, but no oscillation.

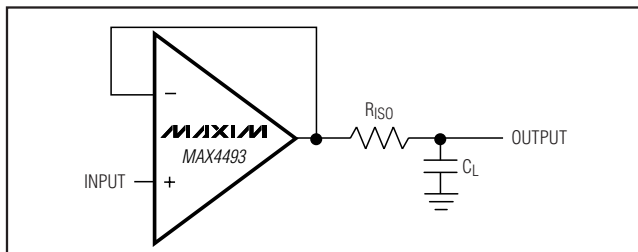

Figure 1. Capacitive Load Driving Circuit

Full-Power Bandwidth

The FPBW is given by:

$$FPBW(\text{Hz}) = \frac{SR}{\pi [V_{OUTp-p}(\text{max})]}$$

SC70, Low-Power, General-Purpose, Dual-Supply, Rail-to-Rail Op Amps

where the slew rate (SR) is $3V/\mu s$. Figure 2 shows the full-power bandwidth as a function of the peak-to-peak AC output voltage.

Power-Up Conditions

The MAX4493/MAX4494/MAX4495 typically settle within $3\mu s$ after power-up. See Power-Up Time in *Typical Operating Characteristics*.

Power Supplies and Layout

The MAX4493/MAX4494/MAX4495 operate with dual supplies from $\pm 2.25V$ to $\pm 5.5V$. Bypass both V_{CC} and V_{EE} with their own $0.1\mu F$ capacitor to ground.

Good layout technique helps optimize performance by decreasing the amount of stray capacitance at the op amp's inputs and outputs. To decrease stray capacitance, minimize trace lengths by placing external components close to the op amp's pins.

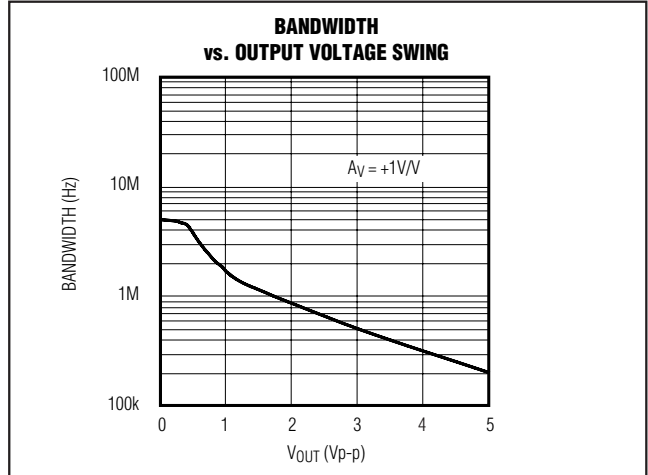
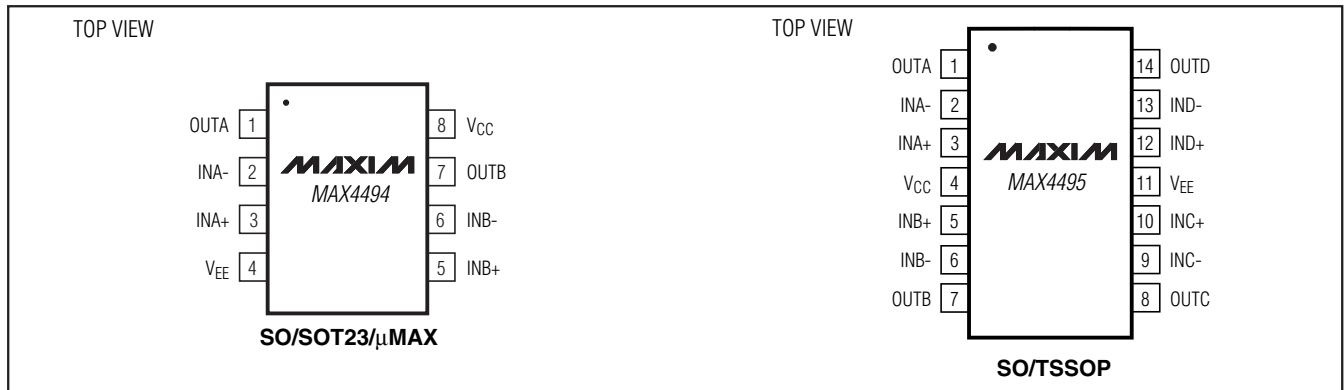
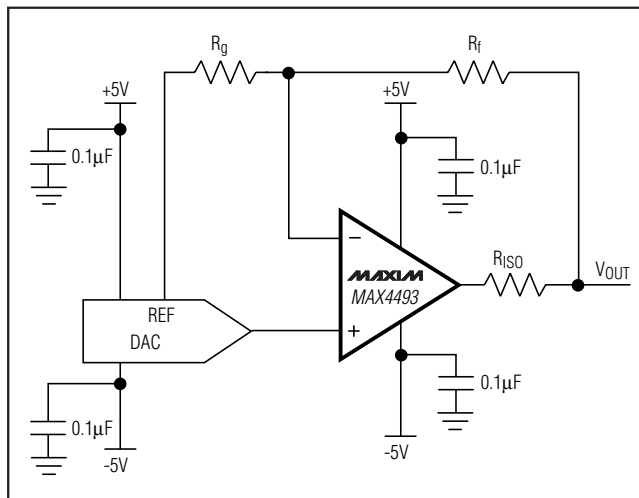

Figure 2. Bandwidth vs. Peak-to-Peak AC Voltage Plot

Pin Configurations (continued)



Typical Operating Circuit



Chip Information

PROCESS: Bipolar

SC70, Low-Power, General-Purpose, Dual-Supply, Rail-to-Rail Op Amps

Package Information

For the latest package outline information and land patterns, go to www.maxim-ic.com/packages. Note that a "+", "#", or "-" in the package code indicates RoHS status only. Package drawings may show a different suffix character, but the drawing pertains to the package regardless of RoHS status.

PACKAGE TYPE	PACKAGE CODE	DOCUMENT NO.
14 TSSOP	U14-1	21-0066
5 SOT23	U5-1	21-0057
5 SC70	X5-1	21-0076
8 SO	S8-2	21-0041
8 SOT23	K8-5	21-0078
8 μ MAX	U8-1	21-0036
14 SO	S14-1	21-0041

MAX4493/MAX4494/MAX4495

TOP VIEW
MARKING: AAAA, N, 1, H

BOTTOM VIEW
1

BENT LEAD DETAIL
bbb

SIDE VIEW
D, A, A₁, SEATING PLANE, 0.10 C

END VIEW
SEE DETAIL A, A₂, E, C

DETAIL A
0.25 BSC, PARTING LINE, CC, L

LEAD TIP DETAIL
WITH PLATING, BASE METAL, b, b₁, c₁, c

SYMBOL	COMMON DIMENSIONS			
	MILLIMETERS		INCHES	
	MIN.	MAX.	MIN.	MAX.
A	—	1.10	—	.043
A ₁	0.05	0.15	.002	.006
A ₂	0.85	0.95	.033	.037
b	0.19	0.30	.007	.012
b ₁	0.19	0.25	.007	.010
c	0.09	0.20	.004	.008
c ₁	0.09	0.14	.004	.006
D	SEE VARIATIONS SEE VARIATIONS			
E	4.30	4.50	.169	.177
e	0.65 BSC		.026 BSC	
H	6.25	6.55	.246	.258
L	0.50	0.70	.020	.028
N	SEE VARIATIONS SEE VARIATIONS			
α	0°	8°	0°	8°
bbb	0.10 MAX			

JEDEC MO-153	N	PKG. CODES	VARIATIONS			
			MILLIMETERS		INCHES	
			MIN.	MAX.	MIN.	MAX.
AB-1	14	D U14-1; U14-2	4.90	5.10	.193	.201
AB	16	D U16-1; U16-2	4.90	5.10	.193	.201
AC	20	D U20-2; U20M-2 U20-3	6.40	6.60	.252	.260
AD	24	D U24-1	7.70	7.90	.303	.311
AE	28	D U28-1; U28-2; U28-3	9.60	9.80	.378	.386

NOTES

- DIMENSIONS D AND E DO NOT INCLUDE FLASH
- MOLD FLASH OR PROTRUSIONS NOT TO EXCEED 0.15mm PER SIDE
- CONTROLLING DIMENSION: MILLIMETER
- MEETS JEDEC OUTLINE MO-153. SEE JEDEC VARIATIONS TABLE
- "N" REFERS TO NUMBER OF LEADS
- LEAD COPLANARITY 0.10 MM MAX.
- NUMBER OF LEADS SHOWN ARE FOR REFERENCE ONLY
- MARKING IS FOR PACKAGE ORIENTATION REFERENCE ONLY
- BENT LEAD 0.10 MM MAX.
- ALL DIMENSIONS APPLY TO BOTH LEADED (-) AND PBFREE (+) PKG. CODES.

-DRAWING NOT TO SCALE-

MAXIM

TITLE:
PACKAGE OUTLINE,
TSSOP 4.40mm BODY

APPROVAL	DOCUMENT CONTROL NO. 21-0066	REV. J 1/1
----------	---------------------------------	------------

TSSOP4.40mm.EPS

SC70, Low-Power, General-Purpose, Dual-Supply, Rail-to-Rail Op Amps

Package Information (continued)

For the latest package outline information and land patterns, go to www.maxim-ic.com/packages. Note that a "+", "#", or "-" in the package code indicates RoHS status only. Package drawings may show a different suffix character, but the drawing pertains to the package regardless of RoHS status.

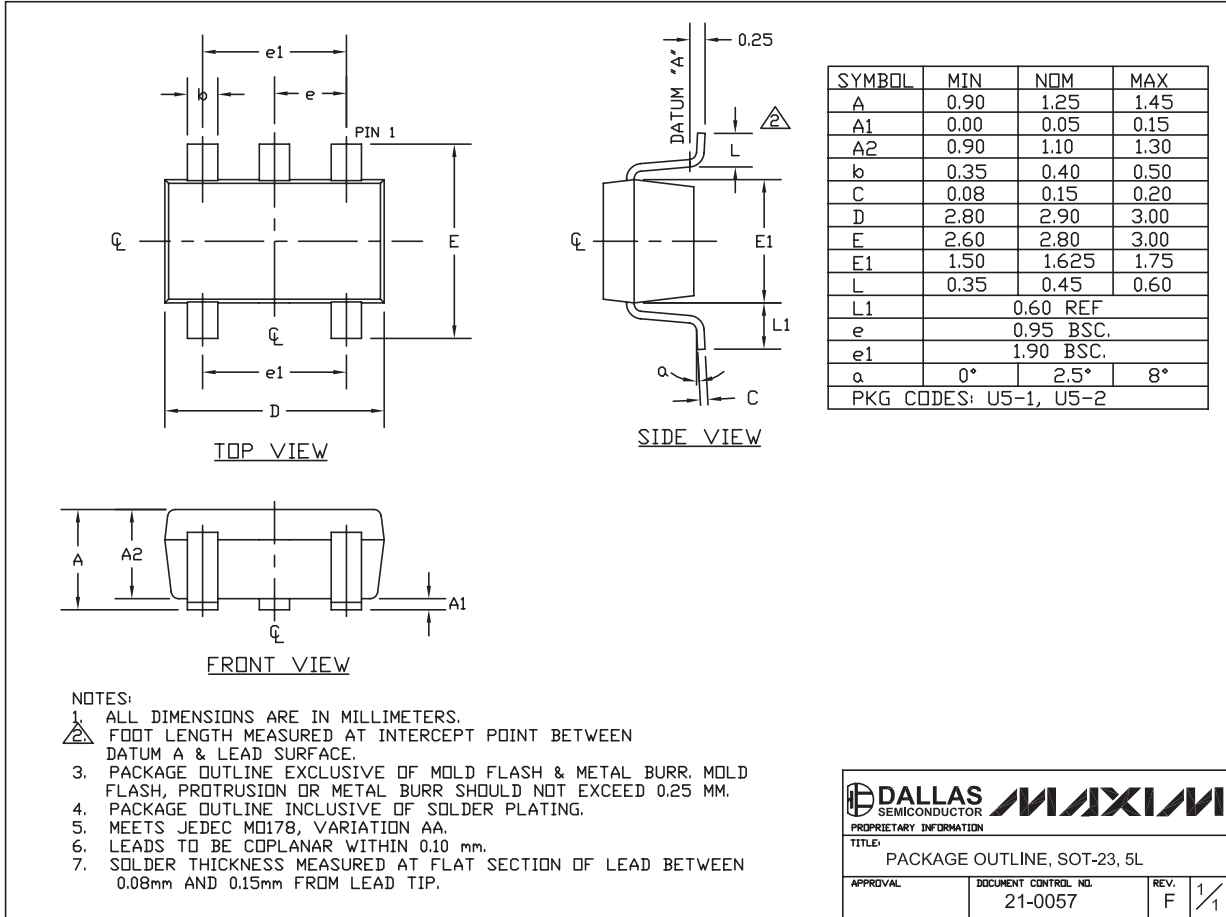

SOT-23 5L EPSS

SC70, Low-Power, General-Purpose, Dual-Supply, Rail-to-Rail Op Amps

Package Information (continued)

For the latest package outline information and land patterns, go to www.maxim-ic.com/packages. Note that a "+", "#", or "-" in the package code indicates RoHS status only. Package drawings may show a different suffix character, but the drawing pertains to the package regardless of RoHS status.

MAX4493/MAX4494/MAX4495

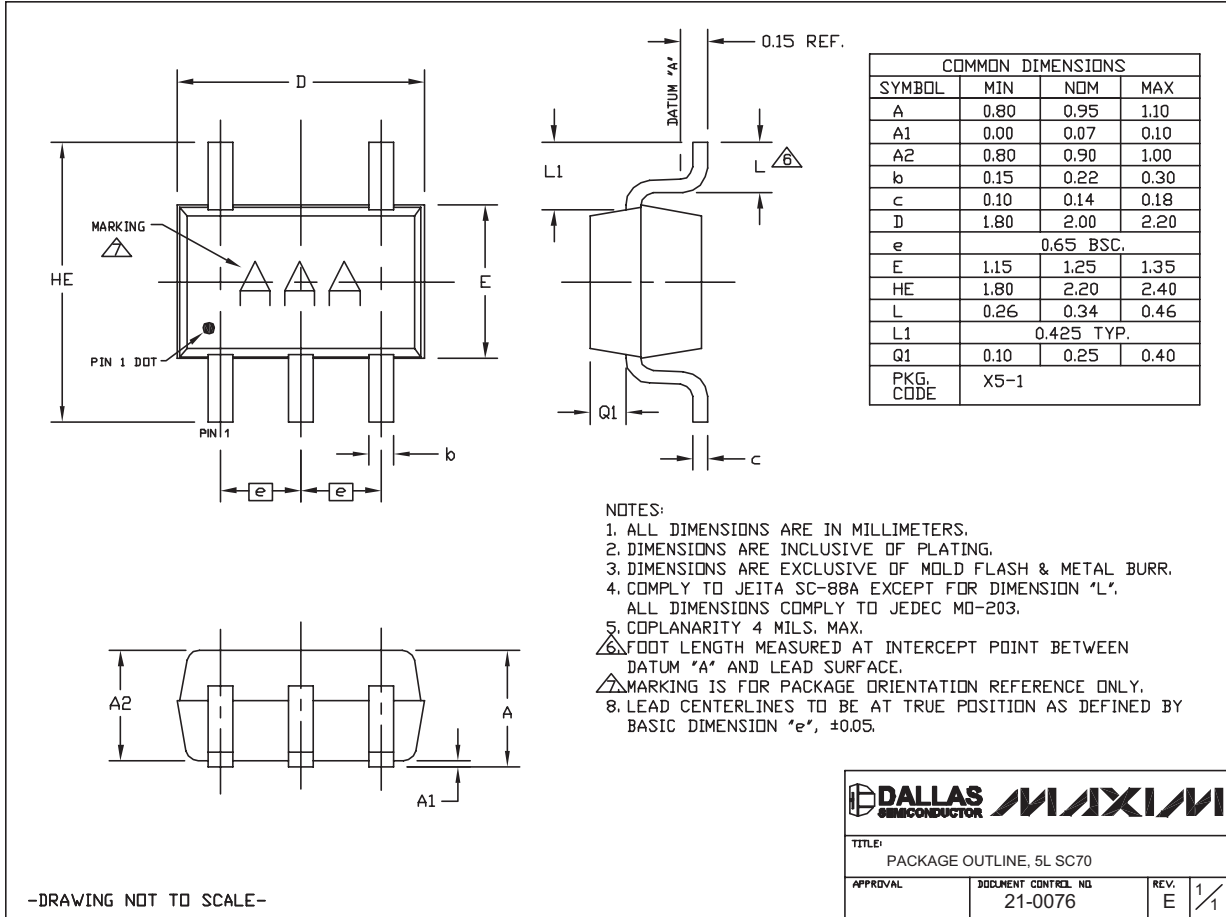

SC70, 5LEPS

DALLAS SEMICONDUCTOR **MAXIM**

TITLE: PACKAGE OUTLINE, 5L SC70

APPROVAL	DOCUMENT CONTROL NO. 21-0076	REV. E	1/1
----------	---------------------------------	-----------	-----

SC70, Low-Power, General-Purpose, Dual-Supply, Rail-to-Rail Op Amps

Package Information (continued)

For the latest package outline information and land patterns, go to www.maxim-ic.com/packages. Note that a "+", "#", or "-" in the package code indicates RoHS status only. Package drawings may show a different suffix character, but the drawing pertains to the package regardless of RoHS status.

TOP VIEW

END VIEW

SIDE VIEW

COMMON DIMENSIONS				
SYMBOL	INCHES		MM	
	MIN.	MAX.	MIN.	MAX.
A	.053	.069	1.35	1.75
A1	.004	.010	0.10	0.25
b	.014	.019	0.35	0.49
c	.007	.010	0.19	0.25
E	.150	.157	3.80	4.00
e	.050 BSC		1.27 BSC	
H	.228	.244	5.80	6.20
L	.016	.050	0.40	1.27
α	0°	8°	0°	8°

VARIATION A				
SYMBOL	INCHES		MM	
	MIN.	MAX.	MIN.	MAX.
D	.189	.197	4.80	5.00
N	8			
MS012	AA			
PKG. CODE	S8-2, S8-4, S8-5, S8-6F, S8-7F, S8-8F, S8-10F, S8-11F, S8-16F			

VARIATION B				
SYMBOL	INCHES		MM	
	MIN.	MAX.	MIN.	MAX.
D	.337	.344	8.55	8.75
N	14			
MS012	AB			
PKG. CODE	S14-1, S14-4, S14-5, S14-6; S14M-4, S14M-5, S14M-6, S14M-7			

VARIATION C				
SYMBOL	INCHES		MM	
	MIN.	MAX.	MIN.	MAX.
D	.386	.394	9.80	10.00
N	16			
MS012	AC			
PKG. CODE	S16-1, S16-3, S16-5, S16-6, S16-8, S16-7F, S16-9F, S16-10F; S16M-3, S16M-6			

NOTES:

- ALL DIMENSIONS ARE IN MILLIMETERS UNLESS OTHERWISE SPECIFIED.
- MATERIAL MUST COMPLY WITH BANNED AND RESTRICTED SUBSTANCES SPEC # 10-0131.
- DIMENSIONS D AND E DO NOT INCLUDE MOLD PROTRUSION. ALLOWABLE MOLD PROTRUSION IS 0.15 MM (.006") PER SIDE.
- LEADS TO BE COPLANAR WITHIN 0.10mm (.004").
- MEETS JEDEC MS012
- ALL DIMENSIONS APPLY TO BOTH LEADED (-) AND PbFREE (+) PKG. CODES.

-DRAWING NOT TO SCALE-

TITLE:
PACKAGE OUTLINE,
8L, 14L, 16L SOIC .150 INCH

APPROVAL	DOCUMENT CONTROL NO. 21-0041	REV. C	1/1
----------	---------------------------------	--------	-----

SC70, Low-Power, General-Purpose, Dual-Supply, Rail-to-Rail Op Amps

Package Information (continued)

For the latest package outline information and land patterns, go to www.maxim-ic.com/packages. Note that a "+", "#", or "-" in the package code indicates RoHS status only. Package drawings may show a different suffix character, but the drawing pertains to the package regardless of RoHS status.

MAX4493/MAX4494/MAX4495

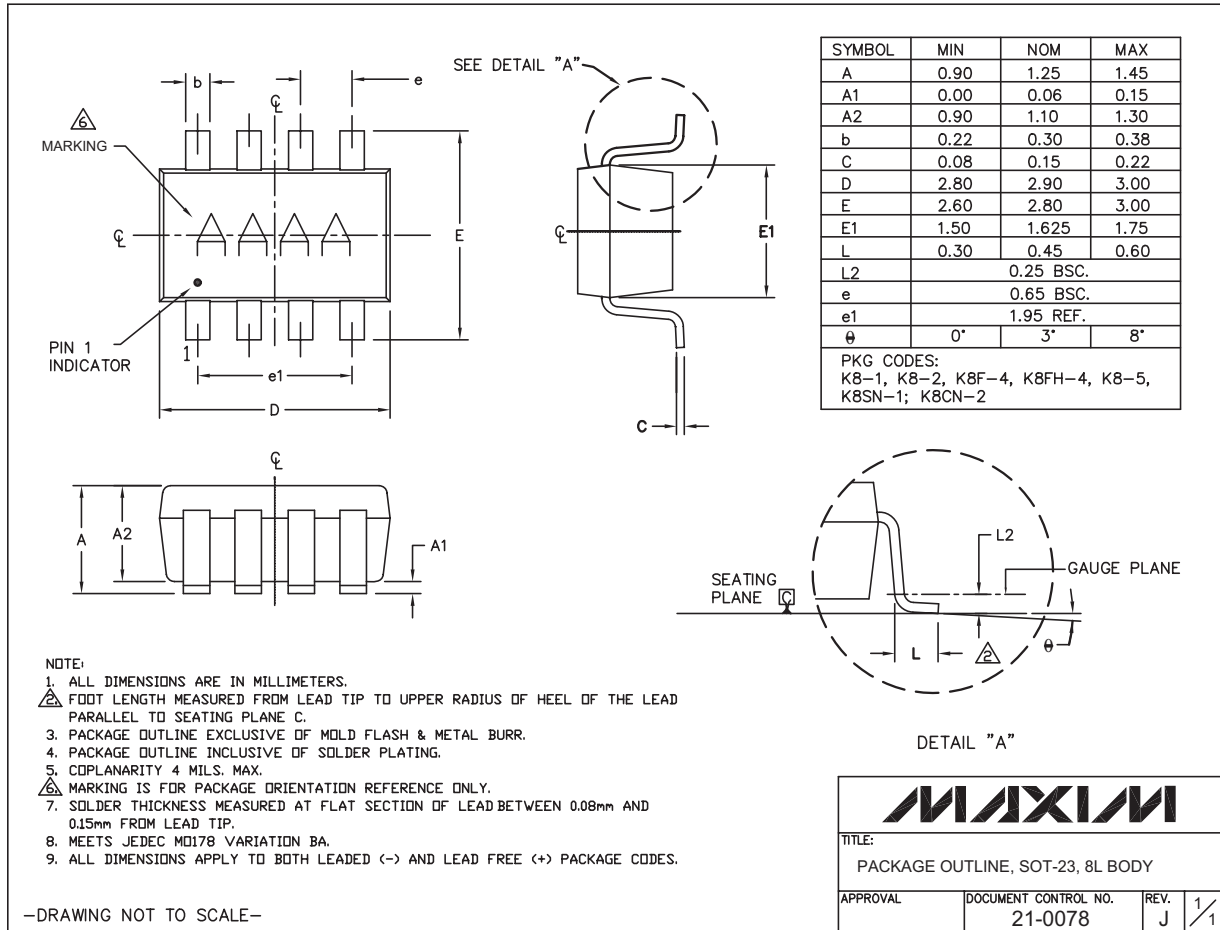

SC70, Low-Power, General-Purpose, Dual-Supply, Rail-to-Rail Op Amps

Package Information (continued)

For the latest package outline information and land patterns, go to www.maxim-ic.com/packages. Note that a "+", "#", or "-" in the package code indicates RoHS status only. Package drawings may show a different suffix character, but the drawing pertains to the package regardless of RoHS status.

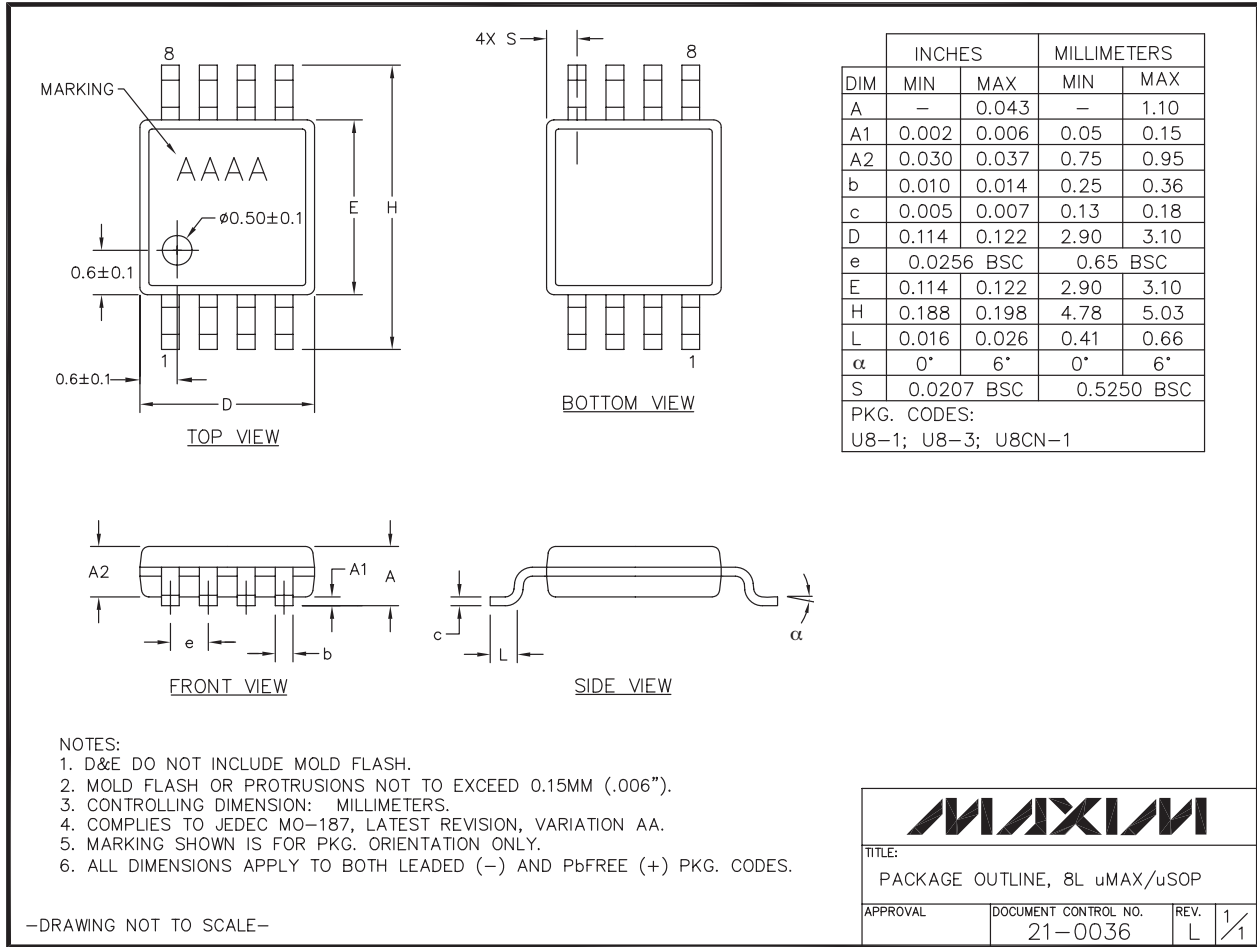

SC70, Low-Power, General-Purpose, Dual-Supply, Rail-to-Rail Op Amps

Revision History

REVISION NUMBER	REVISION DATE	DESCRIPTION	PAGES CHANGED
2	10/08	Updated first paragraph of the <i>General Description</i> section	1
3	12/09	Added lead-free and automotive parts to <i>Ordering Information</i>	1

MAX4493/MAX4494/MAX4495

Maxim cannot assume responsibility for use of any circuitry other than circuitry entirely embodied in a Maxim product. No circuit patent licenses are implied. Maxim reserves the right to change the circuitry and specifications without notice at any time.

Maxim Integrated Products, 120 San Gabriel Drive, Sunnyvale, CA 94086 408-737-7600 _____ 15

Mouser Electronics

Authorized Distributor

Click to View Pricing, Inventory, Delivery & Lifecycle Information:

[Analog Devices Inc.:](#)

[MAX4495ASD+](#) [MAX4495ASD+T](#) [MAX4495AUD+](#) [MAX4495AUD+T](#)